



Standard Model



Teflon-protected Model



Features

- Fast, easy-to-use TEACH-Mode programming; no potentiometer adjustments
- SPDT electromechanical relay for high-capacity switching
- Universal supply voltage: 85 to 264V ac / 24 to 250V dc
- Rugged encapsulated design for harsh environments
- Models available with factory-installed Teflon[®] flange and film coating bonded over the transducer for protection from harsh environments. (Sensor dimensions and mounting vary somewhat from standard models; see dimensions, page 8.)
- Unique housing design allows for multiple mounting configurations
- Choose models with integral 2 m (6.5') or 9 m (30') cable, or with Mini-style or Micro-style quick-disconnect fitting
- Wide operating range of -20° to +70°C (-4° to +158°F)
- Temperature compensation

Teflon[®] is a registered trademark of Dupont™



Models

Models	Sensing Range	Cable*	Supply Voltage	Operation Mode	Output
QT50UVR3W	200 mm to 8 m (8" to 26')	5-wire, 2 m (6.5') cable	85 to 264V ac, 50/60 Hz / 24 to 250V dc	Window-limit (N.O. and N.C.)	SPDT electromechanical relay
QT50UVR3WQ1		5-pin Micro-style QD			
QT50UVR3WQ		5-pin Mini-style QD			
QT50UVR3F		5-wire, 2 m (6.5') cable		Fill-level control (pump-in and pump-out)	
QT50UVR3FQ1		5-pin Micro-style QD			
QT50UVR3FQ		5-pin Mini-style QD			

* NOTES:

- 9 m cables are available by adding suffix "w/30" to the model number of a cabled sensor (e.g., QT50UVR3W w/30).
- A model with a QD connector requires a mating cable; see page 10.

† To order a model with Teflon[®]-protected sensor face and transducer (see page 8), add suffix "-CRFV" to any model number listed above (e.g., QT50UVR3W-CRFV).

Information about dc-voltage models is available on Banner's website: www.bannerengineering.com



WARNING . . . Not To Be Used for Personnel Protection

Never use these products as sensing devices for personnel protection. Doing so could lead to serious injury or death.

These sensors do NOT include the self-checking redundant circuitry necessary to allow their use in personnel safety applications. A sensor failure or malfunction can cause either an energized or de-energized sensor output condition. Consult your current Banner Safety Products catalog for safety products which meet OSHA, ANSI and IEC standards for personnel protection.

U-GAGE™ QT50U Series — Universal Supply Voltage

Overview

Ultrasonic sensors excel in position-monitoring applications and in applications involving clear or multi-colored targets.

QT50U sensors are available in a variety of models: dc sensors with either analog or two discrete outputs, or universal voltage models that feature an SPDT electromechanical relay for switching larger loads. Programming and setup for the universal voltage models are accomplished using the sensor's two push buttons.

Models are available with Teflon sensor face and hex nut, plus Teflon-coated transducer and special o-rings for use in harsh environments, such as fill-level monitoring in an acid-filled tank. See models table, dimensions, and installation information on page 8 for more information.

Principles of Operation

Ultrasonic sensors emit one or multiple pulses of ultrasonic energy, which travel through the air at the speed of sound. A portion of this energy reflects off the target and travels back to the sensor. The sensor measures the total time required for the energy to reach the target and return to the sensor. The distance to the object is then calculated using the following formula:

$$D = \frac{ct}{2}$$

- D** = distance from the sensor to the target
c = speed of sound in air
t = transit time for the ultrasonic pulse

To improve accuracy, an ultrasonic sensor may average the results of several pulses before outputting a new value.

Temperature Effects

The speed of sound is dependent upon the composition, pressure and temperature of the gas in which it is traveling. For most ultrasonic applications, the composition and pressure of the gas are relatively fixed, while the temperature may fluctuate.

In air, the speed of sound varies with temperature according to the following approximation:

In metric units: $C_{m/s} = 20 \sqrt{273 + T_C}$ Or, in English units: $C_{ft/s} = 49 \sqrt{460 + T_F}$
 $C_{m/s}$ = speed of sound in meters per second $C_{ft/s}$ = speed of sound in feet per second
 T_C = temperature in °C T_F = temperature in °F

Temperature Compensation

The speed of sound changes roughly 1% per 6° C (10° F). QT50U series ultrasonic sensors have temperature compensation available; temperature compensation will reduce the error due to temperature by about 90%.

Changes in air temperature affect the speed of sound, which in turn affects the distance reading measured by the sensor. An increase in air temperature shifts both sensing window limits farther away from the sensor. Conversely, a decrease in air temperature shifts both limits closer to the sensor. This shift is approximately 3.5% of the limit distance for a 20° C change in temperature. With temperature compensation enabled, the sensor will maintain the window limits to within 1.8% over the entire -20° to +70° C range.

NOTES:

- If temperature compensation is enabled, exposure to direct sunlight can affect the sensor's ability to accurately compensate for changes in temperature.
- If the sensor is measuring across a temperature gradient, the compensation will be less effective.
- With temperature compensation enabled, the temperature warmup drift upon power-up is less than 1.0% of the sensing distance. After 30 minutes, the apparent switchpoint will be within 0.5% of the actual position. After 60 minutes, the apparent switchpoint will be within 0.3% of the actual position.

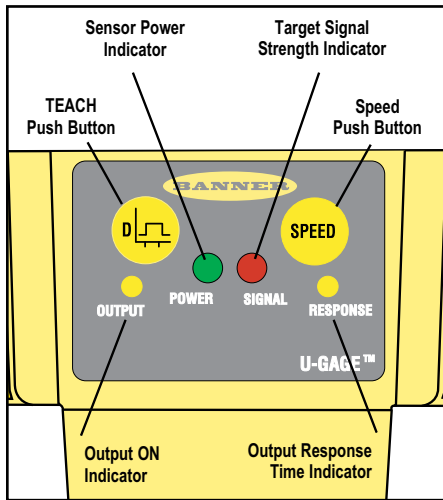

Figure 1. Sensor features





Sensor Programming

Two TEACH methods may be used to program the sensor, using the TEACH push button:

- Teach individual minimum and maximum limits (see page 5), or
- Use the Auto-Window feature to center a sensing window around the taught position (see page 6).

Sensor Configuration

The sensor can be configured for one of three output response times and to enable or disable temperature compensation. Both are accomplished using the sensor's Speed push button, using the procedures described below.

		Push Button Procedure $0.04 \leq \text{"click"} \leq 0.8 \text{ sec.}$	Result
Select Output Response Time	RUN Mode	• No action required	Response LED indicates the current Output Response Time setting: • ON Red – Slow Response (1600 ms) • ON Yellow – Med. Response (400 ms)* • OFF – Fast Response (100 ms)
	Select Response Time	• “Click” the Speed push button until the desired Output Response Time is selected 	• Response LED cycles through ON Red , ON Yellow , and OFF to indicate selected Output Response Time (see above) • No further action required; sensor stores selection and remains in RUN mode
Enable or Disable Temperature Compensation	Enter Programming Mode	• Push and hold the Speed push button for 10 seconds 	Response LED flashes: • Flashing Yellow – Temperature Compensation is enabled* • Flashing Red – Temperature Compensation is disabled
	Enable/Disable	• “Click” the Speed push button to toggle between selections 	Response LED flashes: • Flashing Yellow – Temperature Compensation is enabled* • Flashing Red – Temperature Compensation is disabled
	Return to RUN Mode	• Push and hold the Speed push button for 10 seconds 	• Sensor stores selection • Sensor returns to RUN mode • Response LED returns to a solid color or OFF to indicate current Output Response Time setting

*Factory default settings

U-GAGE™ QT50U Series — Universal Supply Voltage

Status Indicators

Power ON/OFF LED (Green) – ON when sensor power is ON.

Signal LED (Red) – indicates incoming signal strength and condition.

Signal LED Status	Indicates
ON Bright	Good signal
ON Dim	Marginal signal strength
OFF	<ul style="list-style-type: none">• No signal is received*, or• Target is beyond the sensor's range limitations

*If no signal is received, the output will react as if the target is beyond the far limit. The normally open output will be OFF, and the normally closed output will be ON.

Output LED (Yellow or Red) – indicates the target position relative to the window limits, or TEACH mode status.

Output LED Status	Indicates	
RUN Mode	Window-Limit Sensor Models	Fill-Level Control Sensor Models
ON Yellow	Target is within window limits	Level has dropped below far limit
OFF	Target is outside window limits	Level has risen above near limit
TEACH Mode		
ON Red	Waiting for first limit to be taught	
Flashing Red	Waiting for second limit to be taught	

Response LED (Yellow or Red) – indicates sensor output response time selection.

Response LED Status	Indicates
ON Red	Slow response (1600 ms)
ON Yellow	Medium response (400 ms)
OFF	Fast response (100 ms)

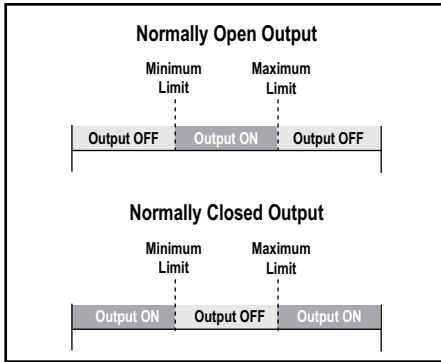





Figure 2. Teaching independent minimum and maximum limits – window limit models

Teaching Minimum and Maximum Limits

Teach procedures are identical for window-limit and fill-level control models. Window-limit models function as shown in Figure 2, and fill-level control models function as shown in Figure 3. To readjust minimum or maximum limits, repeat the teach procedure.

	Push Button Procedure $0.04 \leq \text{"click"} \leq 0.8 \text{ sec.}$	Result
Programming Mode	<ul style="list-style-type: none"> Push and hold TEACH push button for 2 seconds 	<ul style="list-style-type: none"> Output LED turns ON Red Sensor waits for first limit
Teach First Limit	<ul style="list-style-type: none"> Position the target for the first limit "Click" the TEACH push button 	<ul style="list-style-type: none"> Sensor learns the first limit position Output LED changes to Flashing Red
Teach Second Limit	<ul style="list-style-type: none"> Position the target for the second limit "Click" the TEACH push button 	<ul style="list-style-type: none"> Sensor stores both limits Output LED turns ON Yellow Sensor returns to RUN mode

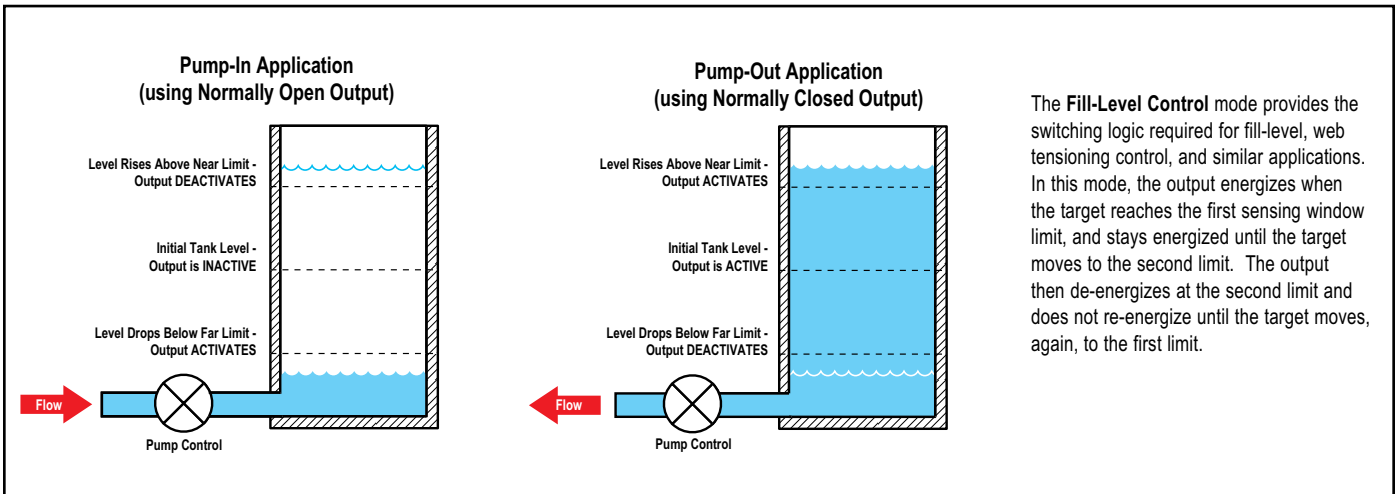





Figure 3. Fill-Level Control

The Fill-Level Control mode provides the switching logic required for fill-level, web tensioning control, and similar applications. In this mode, the output energizes when the target reaches the first sensing window limit, and stays energized until the target moves to the second limit. The output then de-energizes at the second limit and does not re-energize until the target moves, again, to the first limit.

Teaching Limits Using the Auto-Window Feature

Teach procedures are identical for window-limit and fill-level control models. Teaching the same limit twice automatically centers a 200 mm window on the taught position. To readjust the sensing midpoint, repeat the teach procedure.

	Push Button Procedure 0.04 ≤ "click" ≤ 0.8 sec.	Result
Programming Mode	<ul style="list-style-type: none"> Push and hold the TEACH push button for 2 seconds 	<ul style="list-style-type: none"> Output LED turns ON Red Sensor waits for the first limit
Teach Limit	<ul style="list-style-type: none"> Position the target at the desired midpoint for the sensing window "Click" the TEACH push button 	<ul style="list-style-type: none"> Output LED changes to flashing Red
Re-Teach Limit	<ul style="list-style-type: none"> Without moving the target, "click" the push button again 	<ul style="list-style-type: none"> Sensor stores sensing window Output LED turns ON Yellow Sensor returns to RUN mode

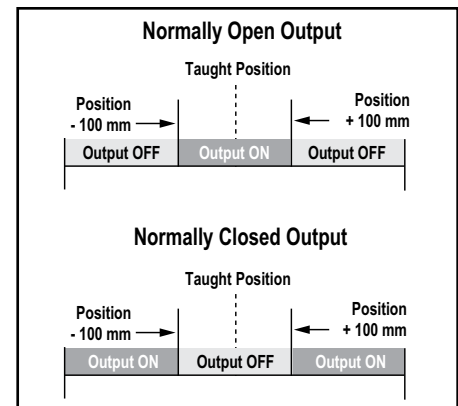

Figure 4. Using the Auto-Window feature for programming

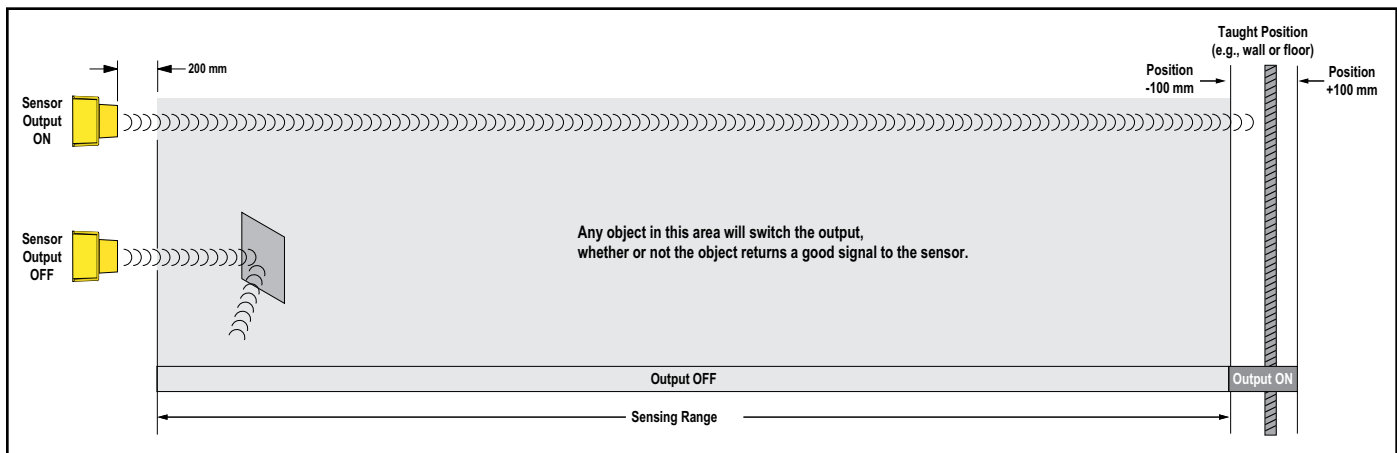



Figure 5. An application for Auto-Window feature (retroreflective mode)

U-GAGE™ QT50U Series — Universal Supply Voltage

Specifications

Sensing Range	200 mm to 8 m (8" to 26')
Supply Voltage	Universal voltage: 85 to 264V ac, 50/60 Hz / 24 to 250V dc (1.5 watts maximum, exclusive of load)
Supply Protection Circuitry	Protected against transient over voltages. DC hookup is without regard to polarity.
Ultrasonic Frequency	75 kHz burst, rep. rate 96 ms
Delay at Power-up	1.5 seconds
Output Configuration	SPDT (Single-Pole, Double-Throw) electromechanical relay output
Output Ratings	<p>Max. switching power (resistive load): 2000 VA, 240 W (1000VA, 120W for sensors with Micro-style QD) Max. switching voltage (resistive load): 250V ac, 125V dc Max. switching current (resistive load): 8A @ 250V ac, 8A @ 30V dc derated to 200 mA @ 125V dc (4A max. for sensors with Micro-style QD)</p> <p>Min. voltage and current: 5V dc, 10 mA Mechanical life of relay: 50,000,000 operations Electrical life of relay at full resistive load: 100,000 operations NOTE: Transient suppression is recommended when switching inductive loads.</p>
Output Response Time	Selectable 1600 ms, 400 ms or 100 ms; see page 3.
Temperature Effect	<p>Uncompensated: 0.2% of distance/°C Compensated: 0.02% of distance/°C</p>
Hysteresis	<p>Window-Limit Sensor Models: 5 mm Fill-Level Control Sensor Models: 0 mm</p>
Repeatability	1.0 mm
Minimum Window Size	20 mm
Adjustments	<p>Sensing limits: TEACH-Mode programming of near and far limits (see pages 5 and 6). Sensor configuration: Output response time and temperature compensation mode (see page 3). Factory default settings: 400 ms output response; Temperature compensation enabled</p>
Indicators	<p>Green Power On LED: Indicates power is ON. Red Signal LED: Indicates target is within sensing range, and the condition of the received signal. Output indicator (bicolor Yellow/Red): Indicates output status or TEACH mode. Response indicator (bicolor Yellow/Red): Indicates output response time selection. See page 4 for more information.</p>
Construction	<p>Transducer: Ceramic/Epoxy composite Housing: ABS Membrane Switch: Polyester CRFV models: Teflon face, flange, hex nut and transducer coating; Viton® o-ring</p>
Operating Conditions	<p>Temperature: -20° to +70° C (-4° to +158° F) Maximum relative humidity: 100%</p>
Connections	2 m (6.5') or 9 m (30') shielded 5-conductor (with drain) PVC jacketed attached cable or 5-pin Micro-style quick-disconnect or 5-pin Mini-style quick-disconnect fitting
Environmental Rating	Leakproof design is rated IEC IP67; NEMA 6P
Vibration and Mechanical Shock	All models meet Mil Std. 202F requirements. Method 201A (vibration: 10 to 60 Hz max., double amplitude 0.06", maximum acceleration 10G). Also meets IEC 947-5-2 requirements: 30G 11 ms duration, half sine wave.
Temperature Warmup Drift	Less than 1.0% of sensing distance upon power-up with Temperature Compensation enabled (see Temperature Effects, page 2)
Application Notes	Objects passing inside the specified minimum sensing distance (200 mm) may produce a false response.
Certifications	

Viton® is a registered trademark of Dupont Dow Elastomers

U-GAGE™ QT50U Series — Universal Supply Voltage

Installation – Chemical-Resistant Models

The sensor may be threaded directly into the side of a tank (see dimensions for hole diameter and thread specifications), or into a non-threaded hole, using the included threaded nut.

For a non-threaded hole, install an o-ring onto the flange, and insert the flange completely into the hole until the sensor front surface is against the tank's exterior surface. Place the other o-ring into the groove on the Teflon nut, and thread the nut onto the flange (see Figure 6). Tighten enough to eliminate gaps between the flange and the tank surface. This will ensure that the o-rings are fully compressed.

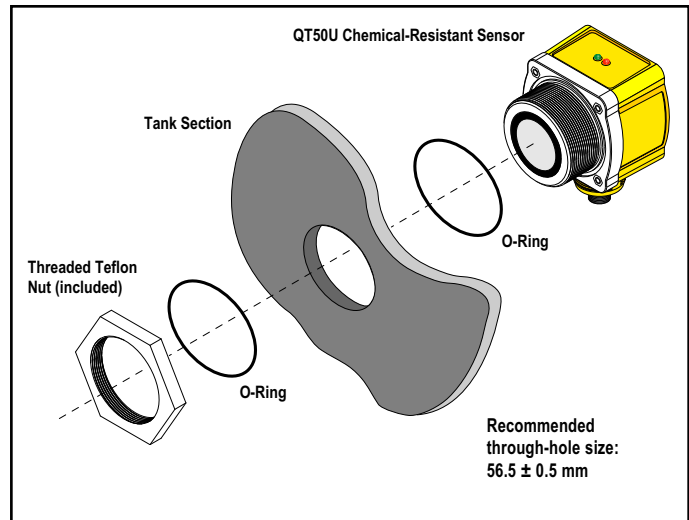
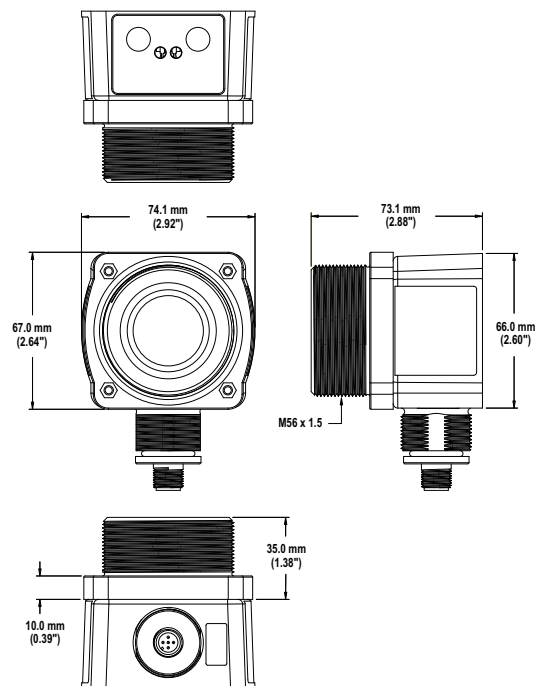
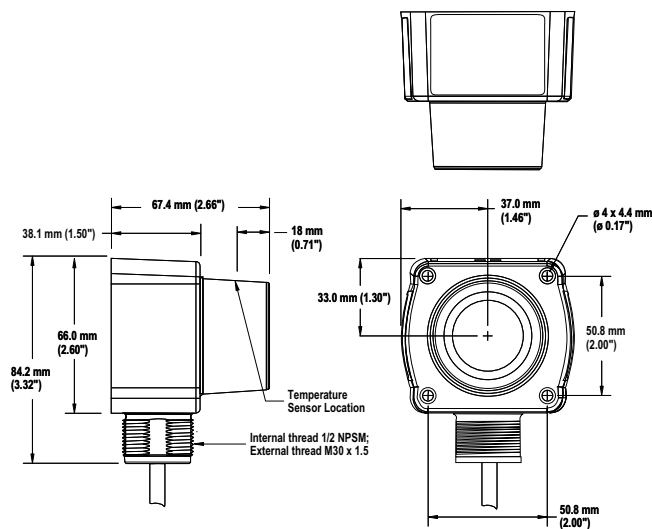

Figure 6. Installing a chemical-resistant sensor model into a non-threaded hole in a tank

Dimensions

Cabled Models

Chemical-Resistant Models



Models with 5-Pin Mini-Style QD

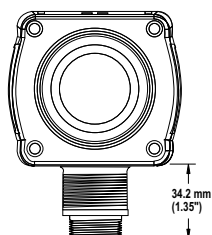

Models with 5-Pin Euro-Style QD

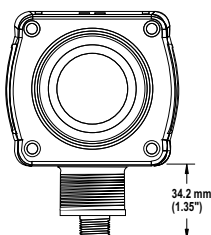

Performance Curves

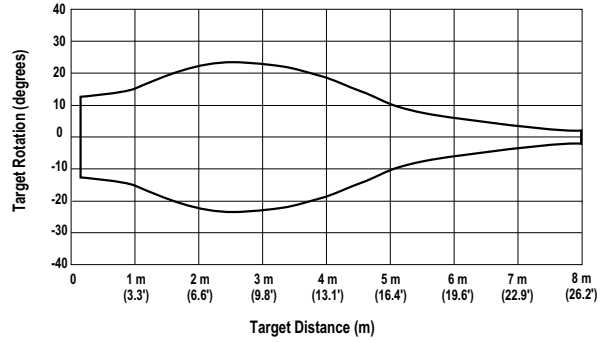
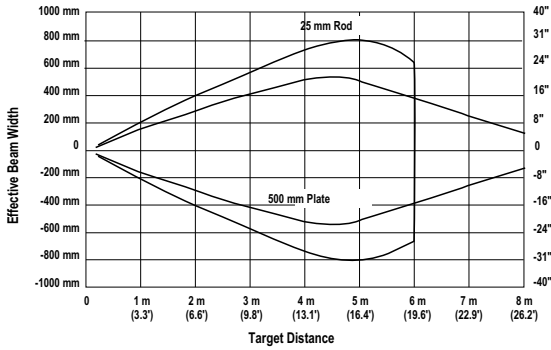

Hookups

Cabled Models

QD Models

Normally Open/Pump-In

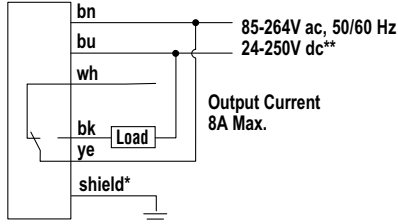

Normally Open/Pump-In

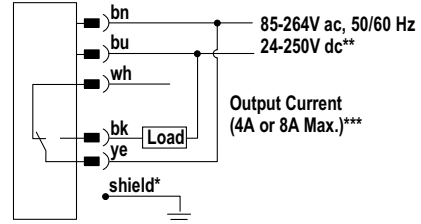

Normally Closed/Pump-Out

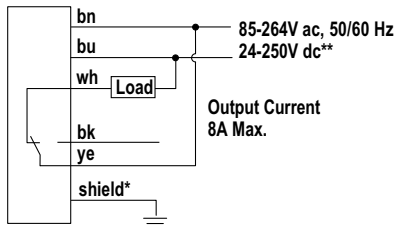

Normally Closed/Pump-Out

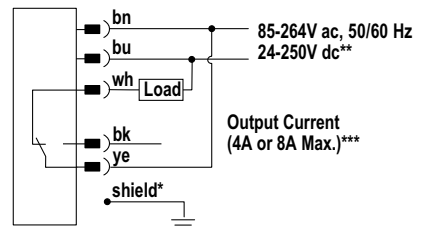

- *It is recommended that the shield wire be connected to earth ground.
- **DC hookup is without regard to polarity.
- ***4A max. for sensors with Micro-style QD; 8A max. for sensors with Mini-style QD.

U-GAGE™ QT50U Series — Universal Supply Voltage

Accessories

Quick-Disconnect (QD) Cable

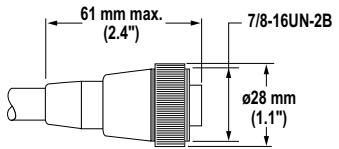
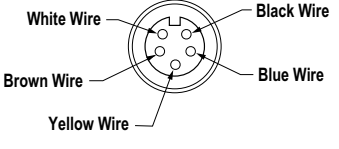
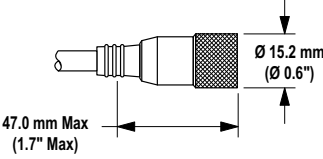
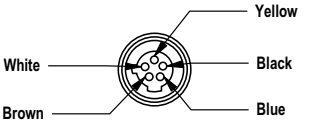
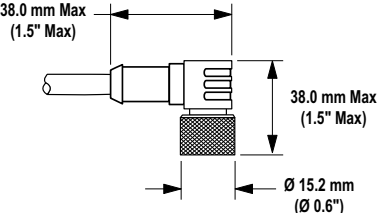
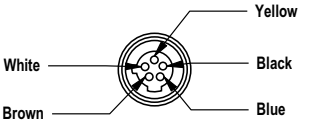
Style	Model	Length	Connector	Pinouts
5-Pin Mini-style with shield	MBCC2-506 MBCC2-512 MBCC2-530	2 m (6.5') 4 m (12') 9 m (30')		
5-Pin Micro-style Straight with shield	MQVR3S-506 MQVR3S-515 MQVR3S-530	2 m (6.5') 5 m (15') 9 m (30')		
5-Pin Micro-style Right-angle with shield	MQVR3S-506RA MQVR3S-515RA MQVR3S-530RA	2 m (6.5') 5 m (15') 9 m (30')		

U-GAGE™ QT50U Series — Universal Supply Voltage

Mounting Brackets			
SMB30SC	<ul style="list-style-type: none"> • 30 mm split clamp with swivel, black reinforced thermoplastic polyester • Stainless steel hardware included 	SMB30MM	<ul style="list-style-type: none"> • 30 mm, 11-gauge, stainless steel bracket with curved mounting slots for versatile orientation • Clearance for M6 (1/4") hardware
SAFQT50U		<ul style="list-style-type: none"> • PVC mounting flange mounts to the front of a QT50U sensor (not for use with chemical-resistant models). • Adapts sensor to thread into standard 2" NPT female threads. <p>NOTE: QT50U sensors are not designed for use in pressurized environments.</p>	
<p>Shown mounted on sensor; sensor not included</p>			
		<ol style="list-style-type: none"> 1. Place o-ring in flange groove. 2. Assemble sensor onto threaded flange as shown, using the M4 screws supplied with the QT50U sensor. 3. Using the supplied hex wrench, torque screws to approximately 10 in/lbs (1.1 kg/m). 4. Mount sensor/flange assembly into 2" NPT fitting. 	

U-GAGE™ QT50U Series — Universal Supply Voltage



WARRANTY: Banner Engineering Corp. warrants its products to be free from defects for one year. Banner Engineering Corp. will repair or replace, free of charge, any product of its manufacture found to be defective at the time it is returned to the factory during the warranty period. This warranty does not cover damage or liability for the improper application of Banner products. This warranty is in lieu of any other warranty either expressed or implied.